

	3A/150V. Die Size-55mil.			
Electrical Characteristics	Symbol	Unit	Spec. limit	Die Sort
Breakdown Voltage @ $I_R=10\text{mA}$	V_{BR}	V	150	160
Average Rectified Forward Current	$I_{F(AV)}$	A	3,0	-
DC Forward Voltage @ 25°C , $I_F=3,0\text{A}$	V_F	V	0,88	0,86
Maximum Reverse Current @ 25°C , $V_R=150\text{V}$ @ 125°C , $V_R=150\text{V}$	I_R	mA	0,005 5,0	0,003 4,0
Peak Forward Surge Current 8,3ms single half sine-wave superimposed on rated load (JEDEC METHOD)	I_{FSM}	A	80	-
Peak Repetitive Reverse Surge Current @ $2,0\mu\text{s}$, $f=1\text{kHz.}$, $T_J<175^\circ\text{C}$.	I_{RRM}	A	1,5	
Electrostatic Discharge Voltage. JEDEC Method. ESD HBM. Contact.	V_{ESD}	kV	± 8 (contact)	
Voltage Rate of Change	dV/dt	$\text{V}/\mu\text{S}$	10.000	
Operating Junction Temperature	T_J	$^\circ\text{C}$	175	

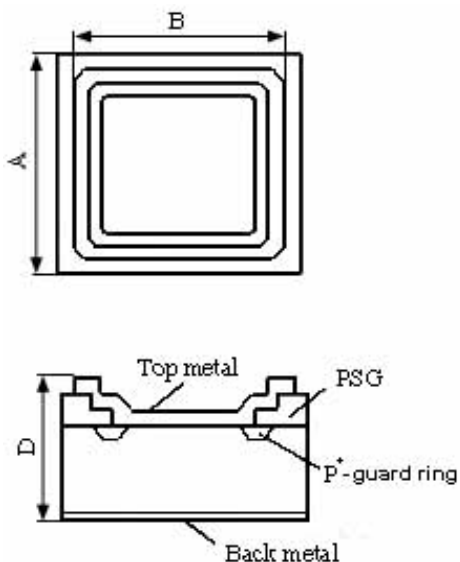

DIM	ITEM	μm
A_x A_y	Wafer Form Die Size	1400 1400
B_x B_y	Top Metal Size	1240 1240
D	Thickness	300max.
	Scribe line Width	80

Top metal:
 a) **Al-Ni-Ag** – for Soldering;
 b) **Al** – for Wire Bonding.
 Backside metal: **Ti-Ni-Ag**.