

SCHOTTKY DIODES KDS 2127A. PRELIMINARY

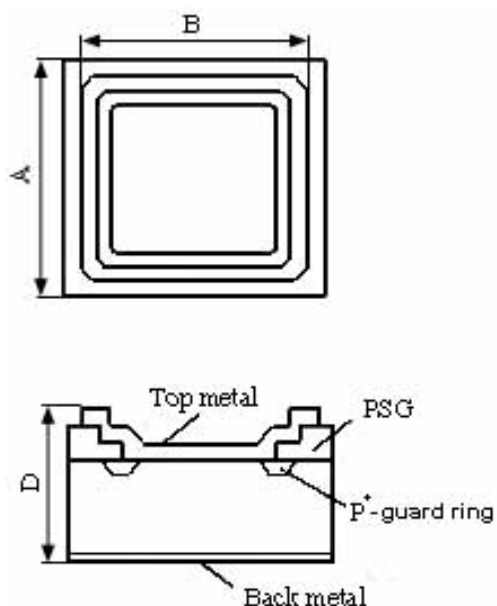

Rev.1. Feb. 2010

 VSP-MIKRON	0,5A/15V. Die Size-35mil.			
Electrical Characteristics	Symbol	Unit	Spec. limit	Die Sort
Breakdown Voltage @ $I_R=10\text{mA}$	V_{BR}	V	18	20
Average Rectified Forward Current	$I_{F(AV)}$	A	0,5	-
DC Forward Voltage @ 25°C , $I_F=0,5\text{A}$	V_F	V	0,33	0,31 (0,30-typ)
Maximum Reverse Current @ 25°C , $V_R=15\text{V}$ 25°C , $V_R=18\text{V}$ 100°C , $V_R=15\text{V}$	I_R	mA	0,9 - 15,0	0,8 1,0 13,0
Peak Forward Surge Current 8,3ms single half sine-wave superimposed on rated load (JEDEC METHOD)	I_{FSM}	A	30	-
Peak Repetitive Reverse Surge Current @ $2,0\mu\text{s}$, $f=1\text{kHz}$., $T_J<125^\circ\text{C}$.	I_{RRM}	A	1,0	
Electrostatic Discharge Voltage. JEDEC Method. ESD HBM. Contact.	ESD	kV	± 8 (contact)	
Voltage Rate of Change	dV/dt	$\text{V}/\mu\text{S}$	10.000	
Operating Junction Temperature	T_J	$^\circ\text{C}$	125	



DIM	ITEM	μm
A_x A_y	Wafer Form Die Size	900 900
B_x B_y	Top Metal Size	760 760
D	Thickness	300max.
Scribe line Width		80

Top metal: a) **Al** – for Wire Bonding;
b) **Al-Ni-Ag** – for Soldering.
Backside metal: **Ti-Ni-Ag**.